



Flexibility for mechanical engineering



Flexibility for mechanical engineering.
Efficient solutions for your clamping plates,
in designated quality, on time - that's STOLLE.



We make high demands.



Especially on ourselves.



Economical, flexible, high-quality solutions – you can count on these with Stolle. From the manufacture of the cast, through development and planning to production with CNC-controlled machines, we provide you with complete clamping technology solutions from a single source. The wide range of possibilities we offer, provides you with numerous options in all aspects of cast iron plate manufacture.

Thanks to our extensive experience in the field of clamping technology, we are able to offer high-precision solutions to fully satisfy even your highest demands. This catalogue offers you the right products to meet your demands. Our own capacity is adjusted to ensure that we can also handle large orders from key accounts in the ideal manner with guaranteed delivery deadlines.

As a family owned company now in its fourth generation, with more than 110 years of tradition and experience in clamping technology, we know our business just as well as we know your demands. You can rely on that!

Content

Floor plates 4 - 8

Clamping rails 9

Technology 10 - 13

Angle plates 14 - 16

Clamping towers 17

Clamping technology 18 - 21



Floor plates

Floor plate area measuring 21.000 x 11.500 mm used as a hydro-pulse test bed. The individual plates measure 7.000 x 2.000 mm and 7.000 x 1.500 mm

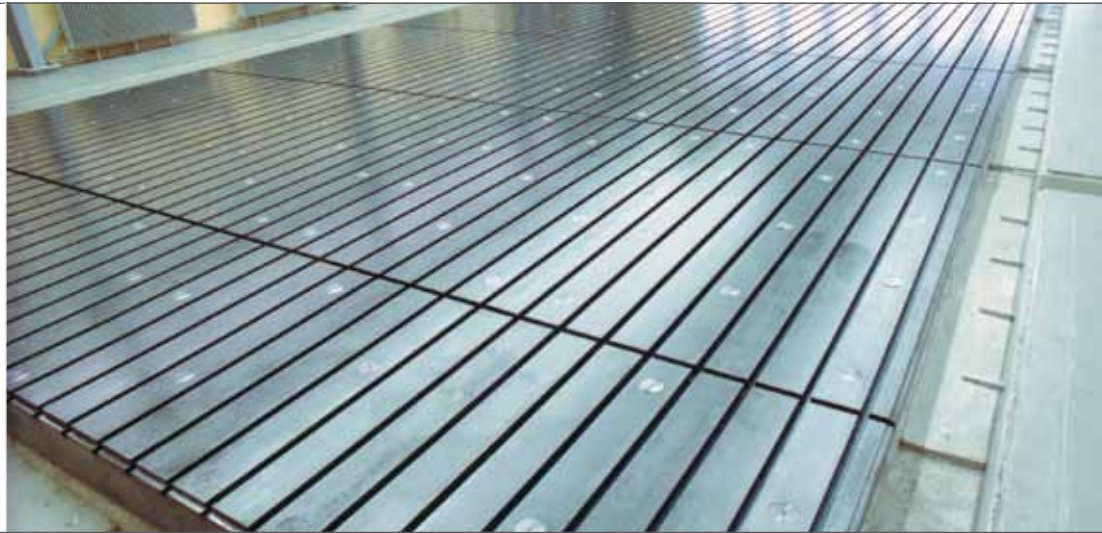

36.000 mm plate field with integrated rotary table for a CNC plate drilling machine

Stolle floor plates are made from a special cast iron / steel alloy. These floor plates offer flexible universal clamping possibilities for all types of workpieces. The Brinell hardness of the standard plates is approx. 180 – 200 HB and the tensile strength is approx. 260 – 300 N/mm². The Stolle floor plates are casted using a special casting process that guarantees minimum stress in the casting and ensures perfect stiffness and stability of the plates. Stolle plates are specially configured to suit customer requirements. The design, dimensions, and loading capacity of the floor plate can be tailored to suit the size and weight of the workpieces to be clamped. The plates by design have a very high stiffness using T-shaped ribs creating a reinforced bottom.

The number and shape of the ribs can be adjusted to suit the specified loading requirements. The size of the T-slots in the plates is determined by the customer's requirements in strength, tensile and compression.

All standard dimensions T-slots in sizes of 14, 18, 22, 28, 36 or 42 for DIN 650 H7 to H12 can be manufactured.

Floor plate with longitudinal and transverse slots and side areas suited for extending the field size

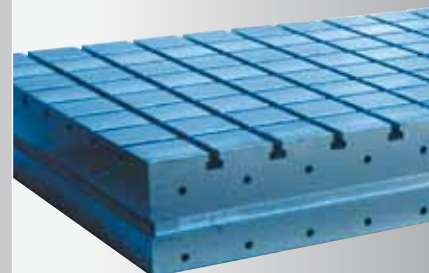

Floor plate with longitudinal and transverse slots providing a wide range of clamping possibilities



Box-shaped angle plate

On standard plates, the T-slot center distances are usually 150, 200, 250 or 300 mm. When individual plates are combined into a plate field, the T-slot layout is chosen so that the clearance to the edge of the plate is exactly half the slot distance. This provides then a uniform T-slot layout over the entire surface.

The slot layout and the clamping possibilities can be adjusted to suit individual customer's requirements.

Depending on the specifications, crossslots, threaded holes, mounting holes, insertion holes and cutouts can be added to the plate. We also offer the installation of zero-point work holding systems.

Due to the customer's application, the plates can be provided in oil- and waterproof versions and can be equipped with an appropriate drainage channel.

Floor plates

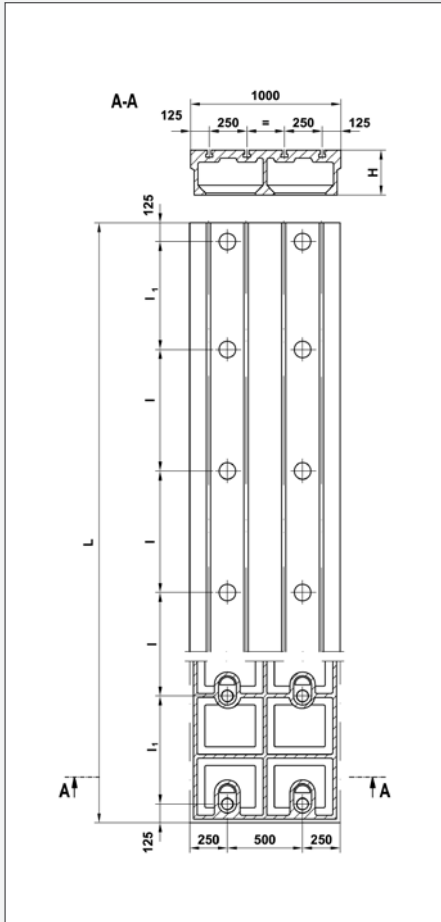

Floor plate 741000

Plate length approx. mm	Number of levelling elements	l	l ₁
2000	6		875
2500	8	810	720
3000	8	974	888
3500	10	2 x 856	769
4000	10	2 x 980	895
4500	12	3 x 886	796
5000	12	3 x 986	896
5500	14	4 x 905	815
6000	14	4 x 985	905
6500	16	5 x 920	825
7000	16	5 x 990	900
7500	18	6 x 928	841
8000	18	6 x 990	905

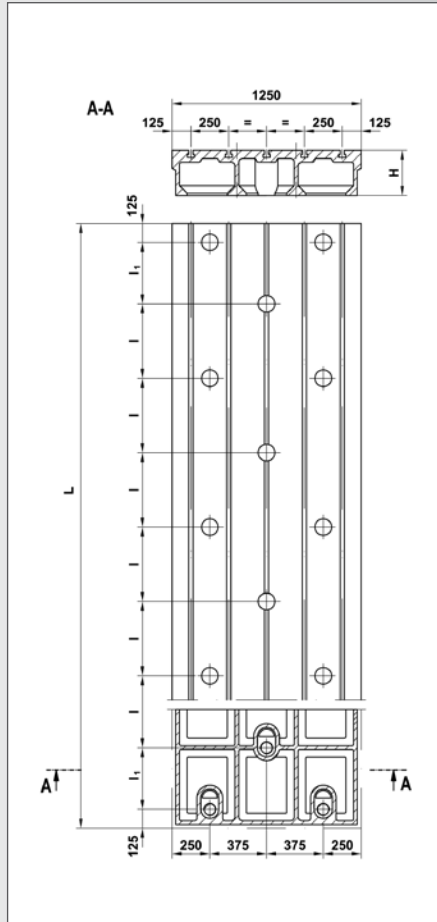

Floor plate 741250

Plate length approx. mm	Number of levelling elements	l	l ₁
2000	8	2 x 480	395
2500	8	2 x 606	519
3000	8	2 x 730	645
3500	11	4 x 570	485
4000	14	6 x 490	405
4500	14	6 x 553	466
5000	17	8 x 492	407
5500	17	8 x 542	457
6000	17	8 x 592	507
6500	20	10 x 535	450
7000	20	10 x 577	490
7500	23	12 x 530	445
8000	23	12 x 566	479

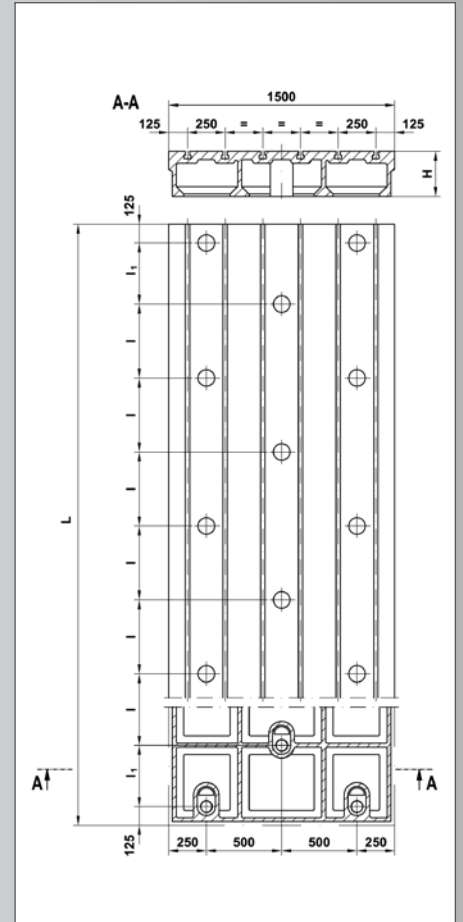

Floor plate 741500

Plate length approx. mm	Number of levelling elements	l	l ₁
2000	8	2 x 480	395
2500	8	2 x 606	519
3000	8	2 x 730	645
3500	11	4 x 570	485
4000	14	6 x 490	405
4500	14	6 x 553	466
5000	17	8 x 492	407
5500	17	8 x 542	457
6000	17	8 x 592	507
6500	20	10 x 535	450
7000	20	10 x 577	490
7500	23	12 x 530	445
8000	23	12 x 566	479

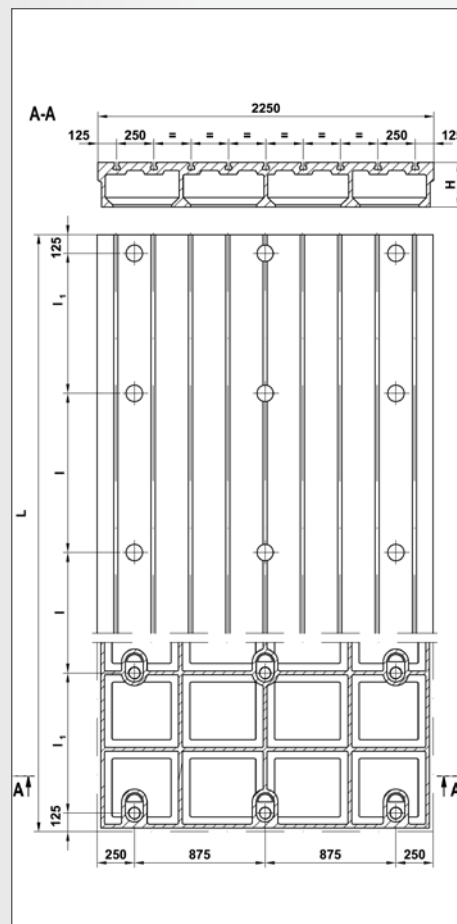
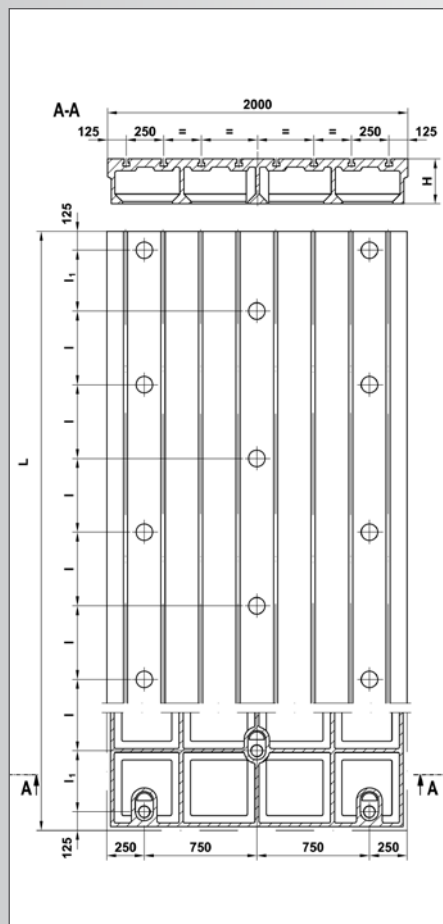
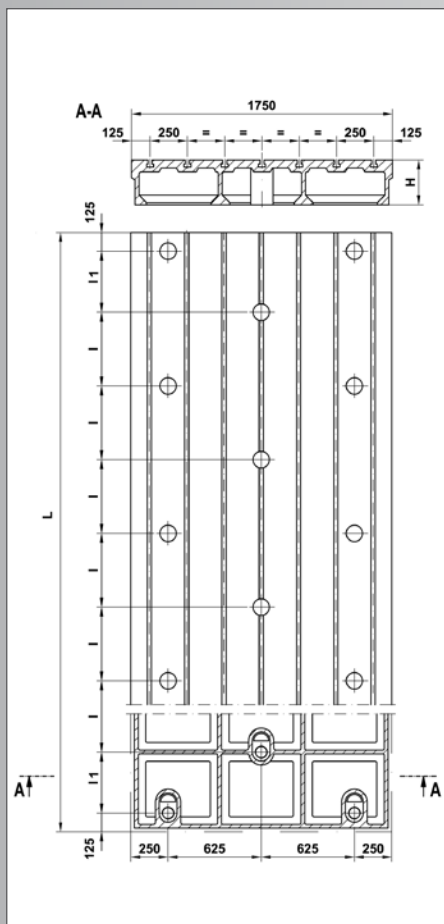

Floor plate 741750

Plate length approx. mm	Number of levelling elements	l	l ₁
2000	8	2 x 480	395
2500	8	2 x 606	519
3000	11	4 x 487	401
3500	11	4 x 570	485
4000	14	6 x 490	405
4500	14	6 x 553	466
5000	17	8 x 492	407
5500	17	8 x 542	457
6000	20	10 x 493	410
6500	20	10 x 535	450
7000	23	12 x 494	411
7500	23	12 x 530	445
8000	23	12 x 566	479

Floor plate 742000

Plate length approx. mm	Number of levelling elements	l	l ₁
2000	8	2 x 480	395
2500	8	2 x 606	519
3000	11	4 x 487	401
3500	11	4 x 570	485
4000	14	6 x 490	405
4500	14	6 x 553	466
5000	17	8 x 492	407
5500	17	8 x 542	457
6000	20	10 x 493	410
6500	20	10 x 535	450
7000	23	12 x 494	411
7500	23	12 x 530	445
8000	23	12 x 566	479

Floor plate 742250

Plate length approx. mm	Number of levelling elements	l	l ₁
2500	9		1125
3000	12	974	888
3500	12	1140	1055
4000	15	2 x 980	895
4500	15	2 x 1106	1019
5000	18	3 x 984	899
5500	21	4 x 904	817
6000	21	4 x 986	903
6500	21	4 x 1070	985
7000	24	5 x 988	905
7500	24	5 x 1060	975
8000	27	6 x 990	905

Floor plates

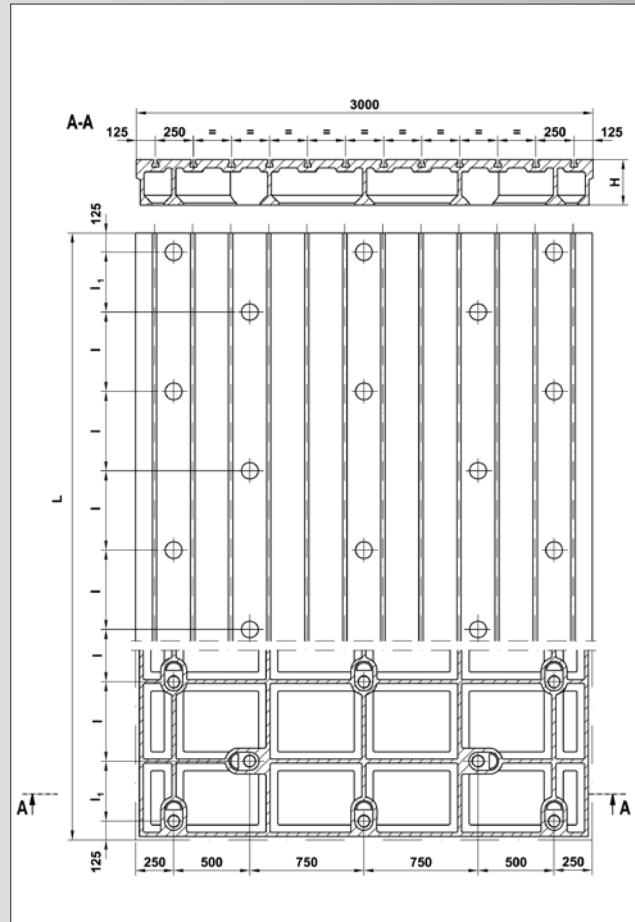
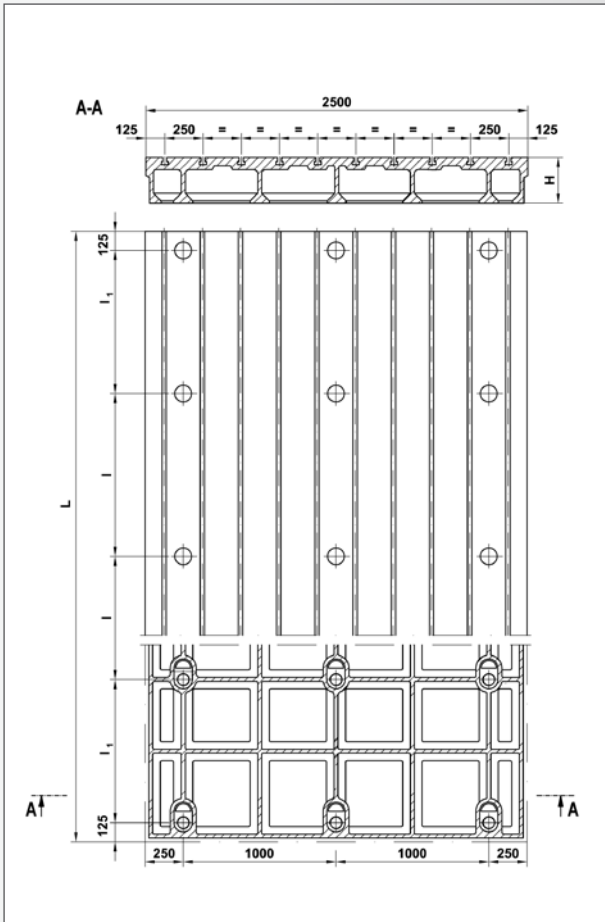

Floor plate 742500

Plate length approx. mm	Number of levelling elements	l	l ₁
2500	9		1125
3000	12	974	888
3500	12	1140	1055
4000	15	2 x 980	895
4500	15	2 x 1106	1019
5000	18	3 x 984	899
5500	21	4 x 904	817
6000	21	4 x 986	903
6500	21	4 x 1070	985
7000	24	5 x 988	905
7500	24	5 x 1060	975
8000	27	6 x 990	905

Floor plate 743000

Plate length approx. mm	Number of levelling elements	l	l ₁
3000	13	2 x 730	645
3500	18	4 x 570	485
4000	23	6 x 490	405
4500	23	6 x 553	466
5000	28	8 x 492	407
5500	28	8 x 542	457
6000	33	10 x 493	410
6500	33	10 x 535	450
7000	38	12 x 494	411
7500	38	12 x 530	445
8000	43	14 x 495	410

Type A floor clamping rail

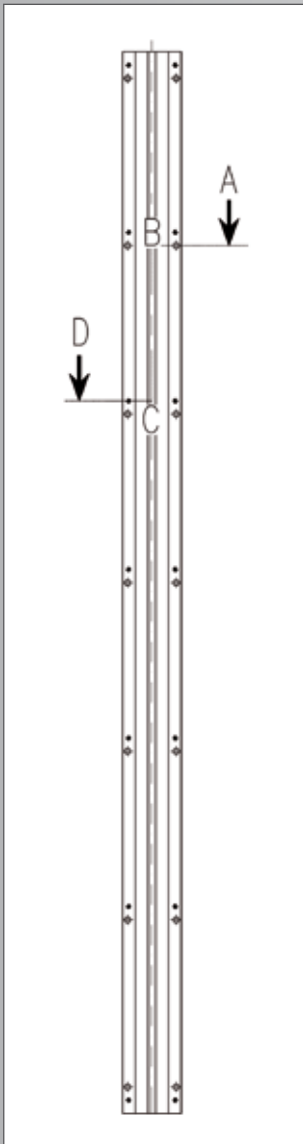

Section A-D

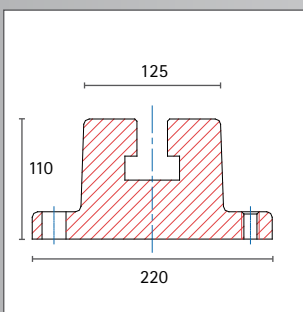

Type B floor clamping rail

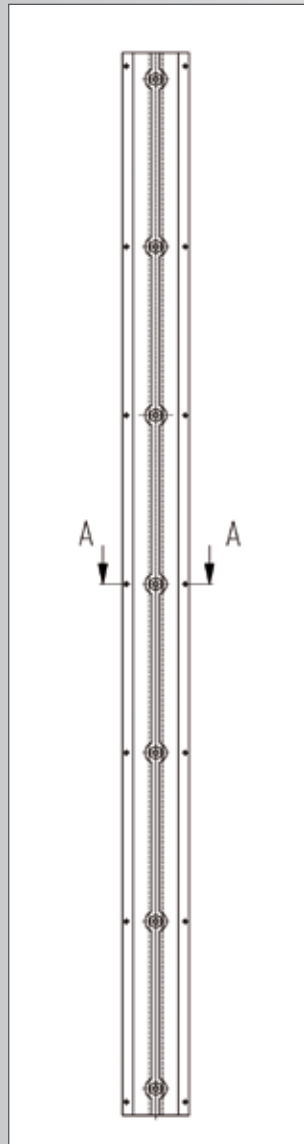

Section A-A

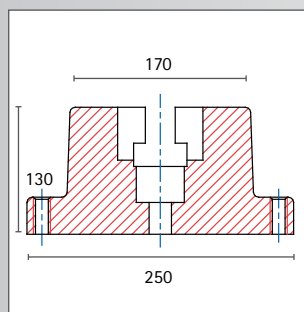

Floor with clamping rails

Stolle floor clamping rails have a wide range of use. Large installation sites can be equipped with versatile clamping possibilities by laying the rails end to end. The floor clamping rails are mounted to the floor using anchor bolts and level screws, then exactly aligned and grouted in place. This provides a surface with the required clamping possibilities. Stolle floor clamping rails have an excellent surface finish. Each rail comes with a T-slot according to DIN 650 and T-slot removal pockets. Floor clamping rails Type A are mounted to the floor using anchor bolts located at both sides of the rail.

Floor clamping rails type B have anchor holes located in the center of the T-slot. The abutting surfaces are machined square to the working surface to allow exact positioning of multiple single rails.

The design, the mould building, the casting, and the machining of floor plates occurs completely at Stolle. Stolle floor plates are designed for the widest possible range of surface loading and applications.

The plates can be individually manufactured to different lengths, widths and heights, and with different ribbing structures. We offer an FEM (finite element method) analysis for cases of extreme loading.

After casting, the plates are machined to a high level of accuracy on CNC controlled milling machines or planing tables. An oil- and waterproof version with a screwed or milled drainage channel is also available.

Several floor plates can be combined into a floor plate field using the appropriate plate connectors. Installation used in-house developed levelling elements selected according to the installation type and the plate loading.



Normal ribbing

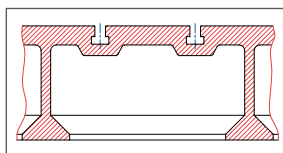

Reinforced ribbing

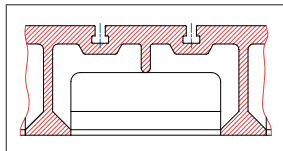

Oil drainage channel

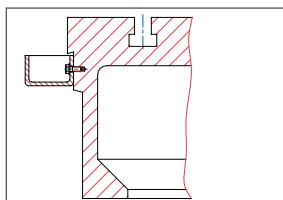

The recommended plate heights for the corresponding m^2 loadings are listed in the table below. The weights per m^2 can be used as an orientation figure for planning the foundation.

Load	Plate height	Weight
to 5 to/m^2	250 mm	approx. 750 kg/m^2
to 10 to/m^2	300 mm	approx. 790 kg/m^2
to 15 to/m^2	300 mm	approx. 840 kg/m^2
to 25 to/m^2	350 mm	approx. 880 kg/m^2
to 35 to/m^2	350 mm	Weight on request, depends on design
to 75 to/m^2	400 mm	
to 150 to/m^2	450 mm	
above 150 to/m^2	500 mm	

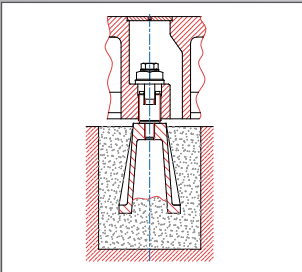

AE 55 levelling element

The AE 55 levelling element is suitable for loads of up to 30 t/m². The complete element consists of a foundation anchor that is cast in the concrete and the actual alignment element which is bolted to the plates. This element allows the plate to be anchored to the foundation and then exactly levelling for tension and compression. The complete element is supplied, including the foundation anchor and steel cover for the clamping plate. Later realignment of the plate with respect to the machine bed is possible at any time from the plate surface.

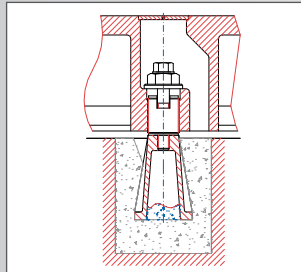

AE 82 / AES 82 levelling elements

This element is suitable for heavier loads from over 30 to approx. 100 t/m². In the AES 82 version an additional steel bushing with a pin is pressed into the floor plate, allowing the element to accept loads of over 100 t/m².

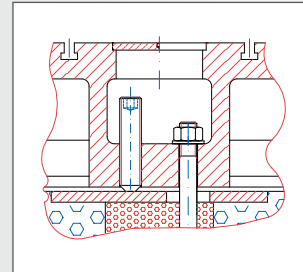

Levelling aggregate AG 30

The AG 30 aggregate is suitable for fixed installation of floor plates and for grouting with non shrinking grout. Every ribbed area has a grouting access. The grout should overlap approx. 10 – 15 cm into the ribbing. Later levelling of the plate after grouting is not possible. Delivery includes level screw and cover plate.

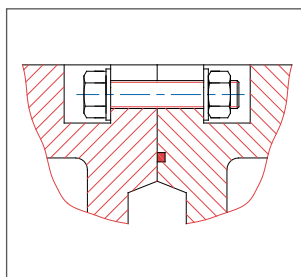

PST 24 plate connector

The plates can be bolted to the plate field. This results in a large level clamping surface composed of several plates but without seams and edges, as if it was cast in a single piece.

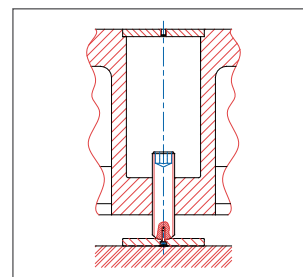

Positioning element ST 30

For installation directly on the hall floor, if a working height as low as possible is desired. The plate is adjusted by changing the height of the square-head bolts. Other types of installation are possible according to customer's requirement!

Surface accuracy and tolerances

The surfaces of clamping, marking, and surface plates are machined according to DIN 876.

A minimum of 3 points are used for measuring the surface accuracy of the plates. The ribbing designed for the specific application transmits the forces occurring during use to the supporting points, providing a correspondingly small level of deformation in the surface to be measured and a high level of surface accuracy.

Surface characteristics:

- DIN 876 /III planed / milled
- DIN 876 /II fine planed / milled
- DIN 876 /I fine milled
- DIN 876 /0 fine scraped with bluing

Flatness tolerances:

The flatness tolerances specify the permissible deviation in μm of the measured surface over the entire length L of the longest edge of the plate. Reference temperature 20 °C

- DIN 876 /III = $40 + L : 25 = \mu\text{m}$
- DIN 876 /II = $20 + L : 50 = \mu\text{m}$
- DIN 876 /I = $10 + L : 100 = \mu\text{m}$
- DIN 876 /0 = $4 + L : 250 = \mu\text{m}$

Tolerance tables

L mm	200	300	500	800	1000	1200	1500	2000	2500
DIN 876 / III	48	52	60	72	80	88	100	120	140
DIN 876 / II	24	26	30	36	40	44	50	60	70
DIN 876 / I	12	13	15	18	20	22	25	30	35
DIN 876 / 0	4,8	5,2	6	7,2	8	8,8	10	12	14

L mm	3000	3500	4000	4500	5000	5500	6000	6500	7000
DIN 876 / III	160	180	200	220	240	260	280	300	320
DIN 876 / II	80	90	100	110	120	130	140	150	160
DIN 876 / I	40	45	50	55	60	65	70	75	80
DIN 876 / 0	16	18	20	22	24	26	28	30	32

T-slots

The T-slots are machined to DIN 650 H12 as standard. Machining to higher levels of accuracy in the tolerance zones H7 or H8 is also possible! Special T-slot dimensions available on request!

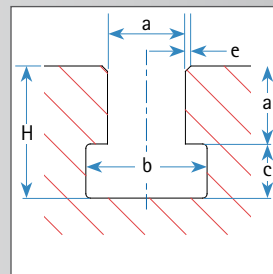

Nominal size: a	for bolts	b	c	H	e
10 mm	M8	17,5 - 18 mm	8 mm	18 mm	1,0 mm
12 mm	M10	20,5 - 21 mm	9 mm	21 mm	1,0 mm
14 mm	M12	1/2"	23,5 - 24 mm	24 mm	1,0 mm
16 mm	M14		26,5 - 27 mm	27 mm	1,0 mm
18 mm	M16	5/8"	29,5 - 30 mm	30 mm	1,5 mm
20 mm	M18		33,5 - 34 mm	34 mm	1,5 mm
22 mm	M20	3/4"	37,5 - 38 mm	38 mm	1,5 mm
24 mm	M22	7/8"	41,0 - 42 mm	42 mm	1,5 mm
28 mm	M24	1"	47,0 - 48 mm	48 mm	1,5 mm
32 mm	M27	1 1/8"	54 mm	54 mm	1,5 mm
36 mm	M30	1 1/4"	60 mm	61 mm	2,0 mm
42 mm	M36	1 1/2"	70 mm	74 mm	2,0 mm

Machined T-slots according to DIN 650

in tolerance zone H 12, keyways in tolerance zones of H7 or H8 available at extra cost

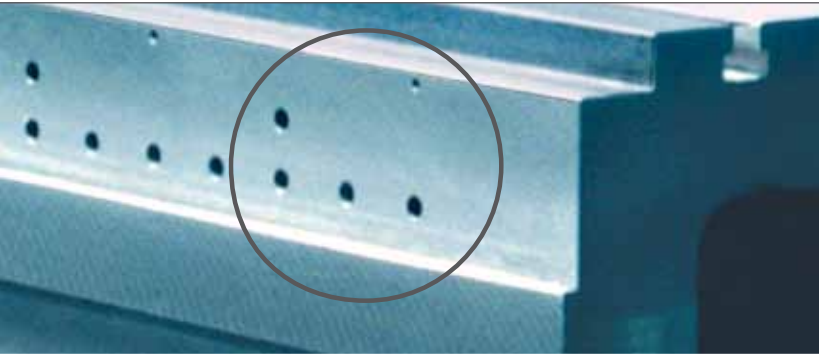

Machine bed of a portal milling machine with mounting surfaces and threaded holes for guide rails

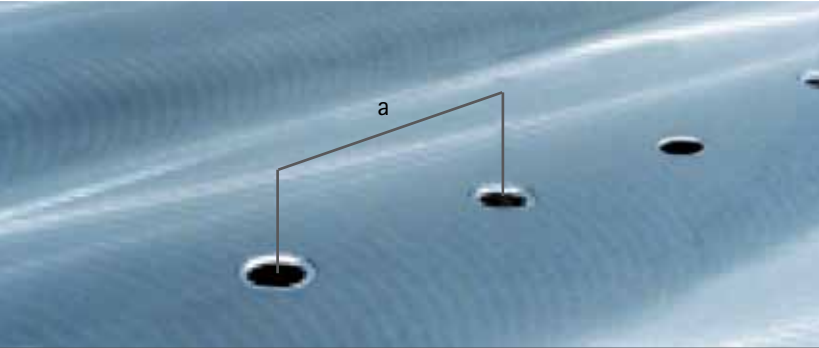
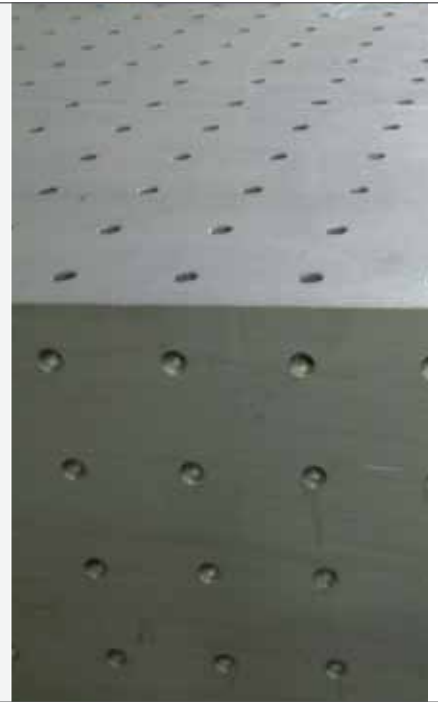

Clearance holes

Clearance tolerances

Clearance tolerances for threaded holes a

0 - 2000	$\pm 0,15$
2000 - 4000	$\pm 0,20$
4000 - 6000	$\pm 0,25$
6000 - 8000	$\pm 0,30$

(in mm) higher tolerances available on request

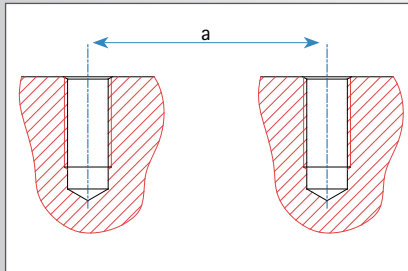

Clearance tolerances for fitted holes a

0 - 1000	$\pm 0,05$
1000 - 2000	$\pm 0,08$
2000 - 3000	$\pm 0,10$
3000 - 4000	$\pm 0,12$
4000 - 5000	$\pm 0,13$
5000 - 6000	$\pm 0,15$

(in mm) higher tolerances available on request

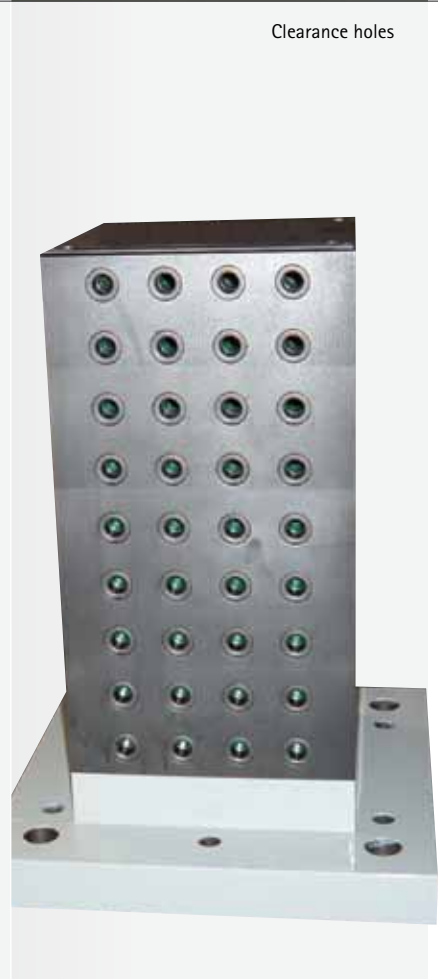
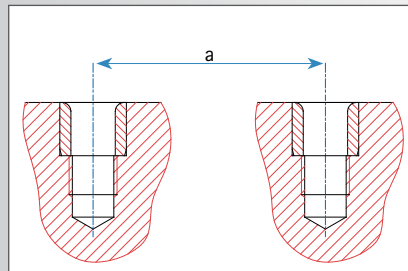

Angle plates

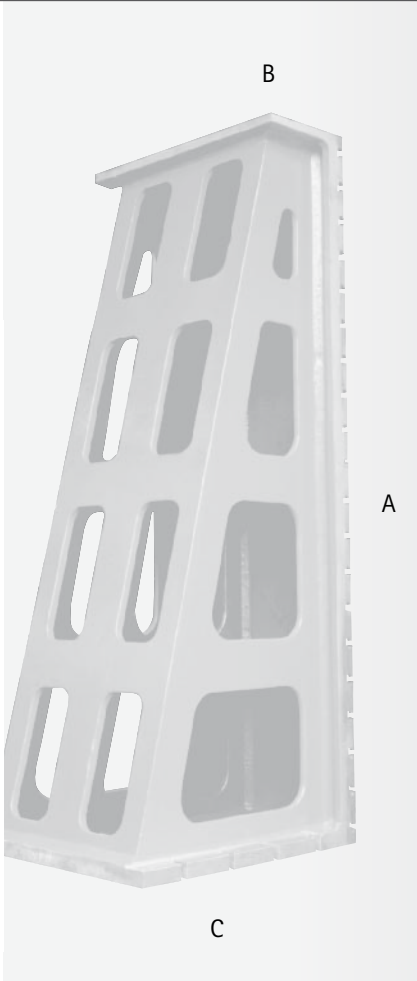

Angle plates, Type SW

A	B	C
1500	800	800
1500	1000	800
1500	1200	800
2000	800	800
2000	1000	800
2000	1200	1000
2000	1500	1000
2500	800	1200
2500	1000	1200
2500	1200	1200
2500	1500	1200
3000	800	1200
3000	1000	1200
3000	1200	1200
3000	1500	1200
3500	1000	1500
3500	1200	1500
3500	1500	1500

Angle plates in a box shape cast design are used for vertically clamping workpieces when using large machine tools of the appropriate power.

The clamping surfaces of the standard angle plates are manufactured according DIN 876/III. They usually have T-slots with a center distance of 250 mm and 125 mm according to DIN 650 22 H12.

The base surfaces of the angle plates have clamping slots and holes that can be adapted to suit the clamping features of the machine table.

Angle plates



The sizes and dimensions of the angle plates and the T-slots can be adjusted to suit your requirements. The angle plates can also be supplied with zero-point clamping systems of your choice.

Large and heavy angle plates can be manufactured in multiple sections. These can then be mounted on top of each other or next to each other, to provide the highest possible or widest possible clamping surface.

2 piece angle plate,
height 4.000 mm

Angle plates

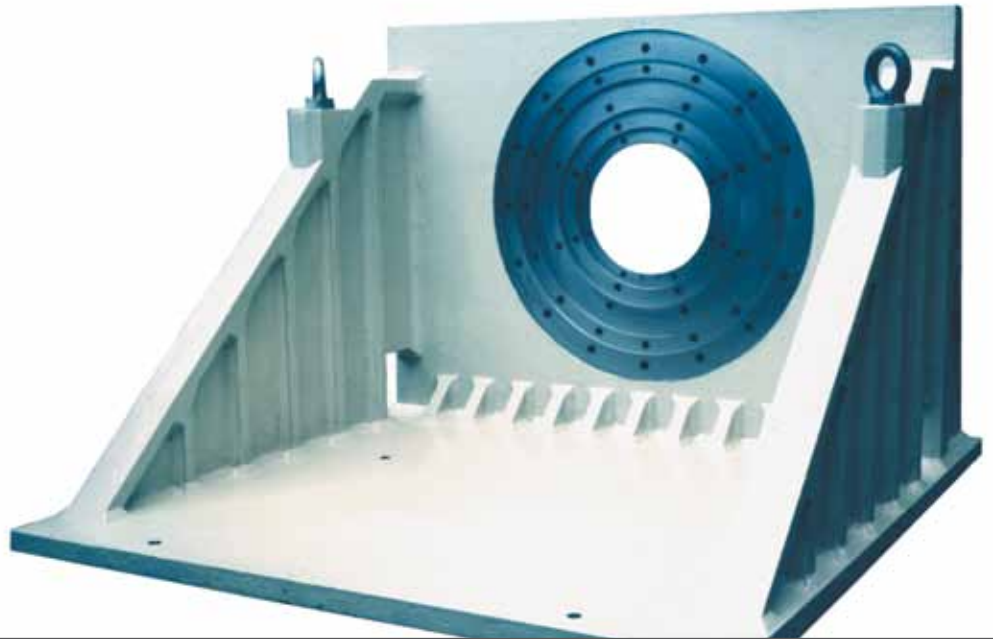

Heavy angle plate for an electric motor test rig, 2.200 x 1.800 x 2.000 mm



Pallet clamping table for 4 x 90 degree pallets, 4 sides with T-slots, height 2.200 mm



Box-shaped angle plate, clamping surface dimensions 3.500 x 2.000 mm



Box-shaped angle plate with 2 clamping surface, 2.000 x 1.000 mm

Cast pieces with an integrated clamping system

Clamping tower



Clamping towers are used for versatile clamping of workpieces on modern CNC controlled machines. They not only provide workpiece clamping using T-slots or hole grids, but can also be equipped with a zero-point clamping system.

The different clamping possibilities can be provided in the clamping tower to the required tolerances as requested. All sizes on request.



Clamping towers with a zero-point clamping system

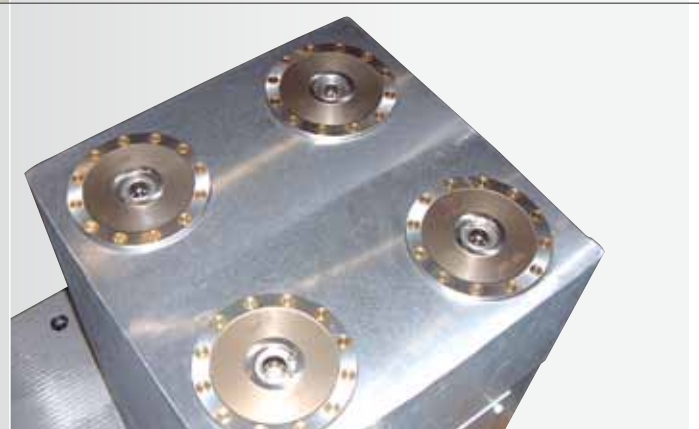

Clamping technology

Machine table,
4.000 x 3.000 x 470 mm
for a milling machine



CNC machining centre, 9.000 x 3.000 mm

Machine table with inner clamping
features, 2.000 x 800 x 800 mm

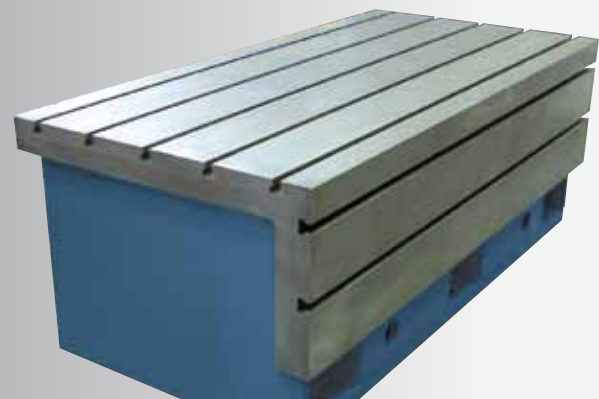



Horizontal table Ø 3.000 mm for heavy loads



Special clamping box



Clamping plate with support on damping system



Clamping technology



Plate area for measuring system



Segment of rotary table with a diameter of 9.000 mm



Machine table 8.200 x 1.250 x 700 mm

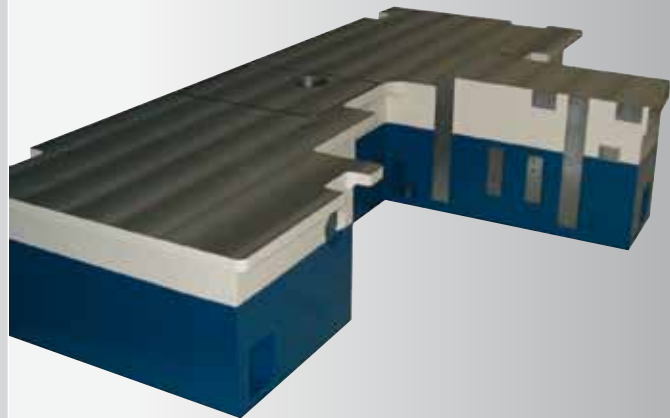

Machine bed for test rig, for vibration insulated installation

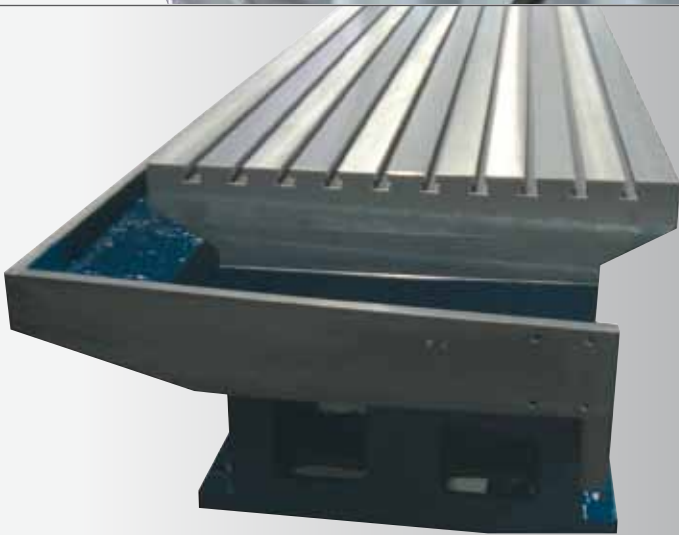

Machine bed with surrounding cast
drainage channel 7.400 x 1.100 x 850 mm



Made in Germany. Used all over the world.

Subcontracting flexibly and quick



With a workforce of more than 150, we manufacture clamping technology products for mechanical engineering and toolmaking applications at our 3 plants in Bonn-Bad Godesberg, Bonn-Beuel and Baarlo/NL. In addition to the planning, construction and production of the cast parts, assembly all over the world is another of our fields of expertise.

We would be pleased to support you with the planning of your projects as a part of the many services we offer as a matter of course.



DIN EN ISO 9001 : 2000

Precision in the measuring industry



Know-how for special solutions



Safety and security for the energy industry



Flexibility for mechanical engineering



Reliability for the automobile industry



Our expertise is not limited to clamping technology. Whether as standard slabs or special solutions, Stolle offers a wide range of cast plates and special constructions made of cast iron.

We also manufacture and deliver test stand plates for the automobile industry and its suppliers – turnkey product solutions in top quality and precision are our speciality here. Our customers in the measuring industry have come to rely on precise, flexible and economically produced measuring and surface plates from Stolle.

We offer individual high-end solutions in top quality for the construction of special machinery. In other industrial sectors too, we plan, construct, manufacture and assemble complete solutions that convince through their stability and quality.

STOLLE

IRON CASTING AND MACHINING

Wilhelm Stolle GmbH
P.O. Box 301 252
53192 Bonn | Germany
phone: +49 (0) 228 950 33-0
fax: +49 (0) 228 950 33-33
E-Mail: info@stolle.net

Production Sites:

Bad Godesberg:
Friesdorfer Straße 137-139
53175 Bonn | Germany

Beuel:
Broichstraße 78-90
53227 Bonn | Germany

Stolle Nederland BV:
Tangweg 1
NL-5991 PE Baarlo
phone: +31 77477 2020
fax: +31 77477 3901
E-Mail: info@stolle.nl

www.stolle.net